

ESPRITE  [®]

TRANSFERABLE ENGINE

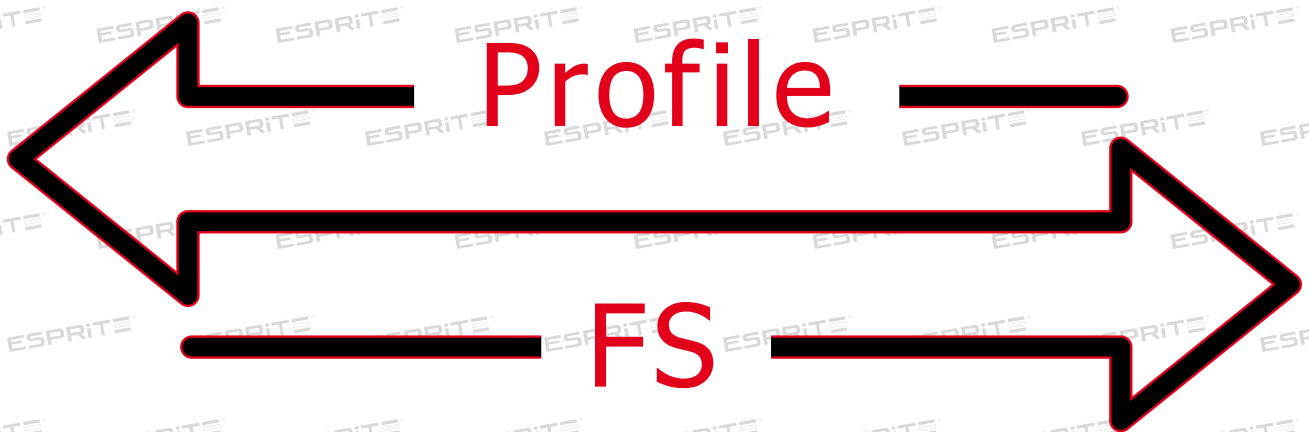

ROBE [®]



ESPRITE®

PIONEERING A NEW ERA IN LUMINAIRES USING WHITE SOURCE LED ENGINES

Our reputation for innovative design, hard-earned over nearly 30 years, is the result of asking questions, listening to customers, and repeatedly redefining the boundaries of technology.

We have the most forward-thinking engineers and designers in our industry. We wanted to address the problem that white source LED engines cannot last forever and vary in colour consistency over time.

The result of this intensive and extensive process provides you with three options: the TE™ 650W HP (High Performance) White LED engine, delivering the highest possible output; the TE™ 650W HCF (High Colour Fidelity) White LED engine, ideal for those requiring exceptional color rendition; or the TE™ 650W TGW (Tungsten White) LED engine, offering the classic feel of traditional tungsten. We have designed, developed, patented, and manufactured these groundbreaking TRANSFERABLE ENGINES in our own factory to ensure the highest performance and consistency.

This means, by having both a cost effective and easily changeable LED engine, we have removed the white source problems of unpredictable life and performance consistency.

Commensurate with this level of technology, the module holds not only its manufacturing date, serial number and hours used, but also other useful information, easily accessible via a simple, free, mobile App using Near Field Communication.

The first fixtures to use this new technology, and to replace old, entire fleets of workhorse discharge fixtures, are the all new, high performance ESPRITE® automated luminaires.

With high output and precision optics, ESPRITE® provides the perfect platform. Not only does it incorporate all the features you would expect from a fixture of its class, it has many design innovations including a new cooling system that removes any airflow over the optics resulting in reduced residue deposits and thus vastly extending periods between cleaning.

As the industry migrates from discharge to LED sources, the ability to provide solutions for the associated white LED source challenges is a monumental shift in LED technology and fixture design.

These factors ensure ESPRITE® enjoys a long life while providing customers with a good return on their investment, a trait that has become synonymous with Robe products.

Josef Valchar
CEO

ROBE®

ESPRITE®

TRANSFERABLE ENGINE



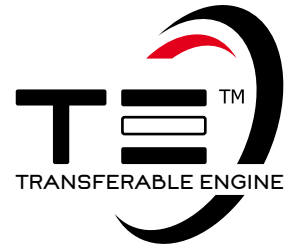

Robe's world-first TE™ – TRANSFERABLE ENGINE guides performance lighting into the future!

Our reputation for innovative design, hard-earned more than 30 years, is the result of asking questions, listening to customers, and repeatedly redefining the boundaries of technology.

We have the most forward-thinking engineers and designers in our industry. We wanted to address the problem that white source LED engines cannot last forever and vary in colour consistency over time. The result of this intensive, and indeed extensive process is the ground-breaking **TRANSFERABLE ENGINE**.

The fast change, low-cost **TRANSFERABLE ENGINE** technology ingeniously solves the problem of performance longevity for those preferring the higher brightness of white source LEDs as an obvious replacement for their ageing stock of discharge workhorses.

To ensure the very best performance and consistency, we have designed, developed, patented, and manufactured the engines all within our own factory in the Czech Republic. They provide a monumental shift in LED technology and fixture design.

Commensurate with this level of technology, every Robe **TRANSFERABLE ENGINE** has its own, unique, memory with all engine data staying with the engine. This means when you transfer the engine to a new fixture, the data travels with it.

All data stored on the **TRANSFERABLE ENGINE** is easily accessible through Near Field Communication (NFC) technology via the ROBE COM app. This provides direct access to the engine information, including engine type and serial number; full module installation history; intensity compared to initial performance; hours worked and much more. All data is available without powering the engine while sitting on your shelf, giving you instant accessibility. Furthermore, when the module is installed in a fixture, the data is available directly from the fixture display.



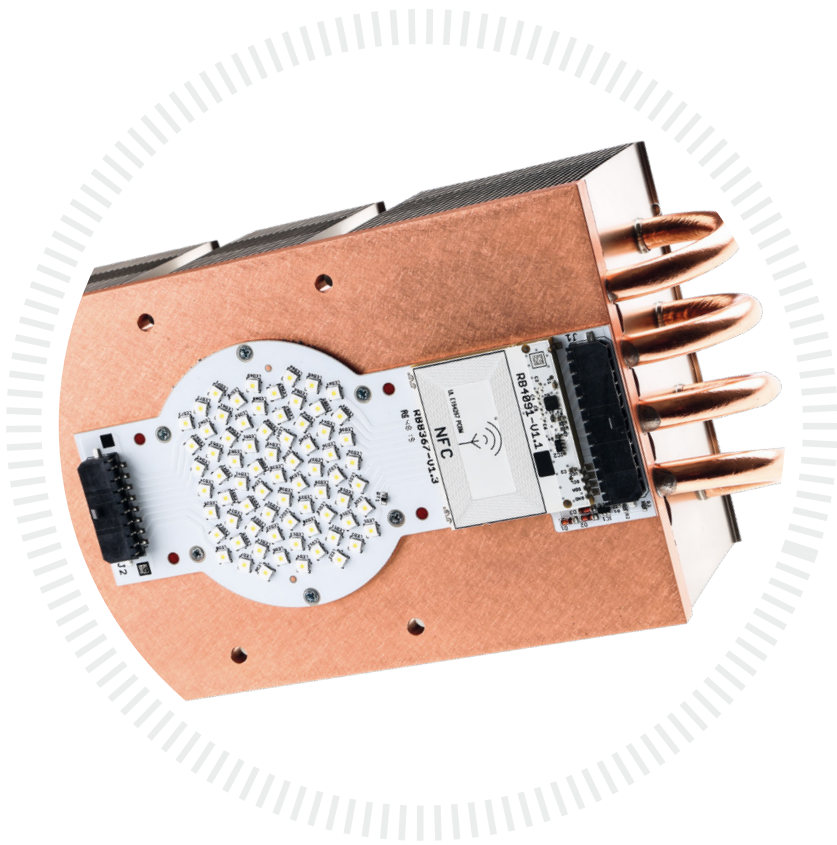

Our **TRANSFERABLE ENGINES** are fast-changing, taking under 5 minutes. They require no special tools, complex procedures or return to workshop or agent. With no alignment or calibration needed, you have a rapid “lamp-like” exchange.

Robe **TRANSFERABLE ENGINES** are very economical, costing approximately twice the price of high-performance discharge lamps. Combined with the advantages of LED, you now have the tools available to maintain a high level of light consistency across your inventory.

Transferable means a new engine at a lower cost, compared to a replacement engine at a far higher price. With no warranty or reduced LED lifetime issues, they carry a four-year 20,000-hour warranty.

Another benefit of the self-referencing engines is their ability, via our unique software, to give you a visual performance reference. Being able to quickly set the outputs to a consistent level, even while the fixtures are up in the rig, will save you a lot of time in the pressurised world of touring.

Robe fixtures utilising the **TRANSFERABLE ENGINES** technology have been deliberately designed with built in capacity to take advantage of possible future LED engine development. This forethought, combined with their ease of transfer, will give you an even greater luminaire longevity.

In line with our stringent Green Policy, when the engines have reached the end of their life, we have the Robe **TRANSFERABLE ENGINES** free return for recycling offer, making them very Eco-friendly.

The **TRANSFERABLE ENGINES** concept pioneers a new era in luminaires using white source LED engines. It gives you the ability to cost-effectively maintain a high level of quality light consistency across your inventory while ensuring the highest level of return on your investment.





Robe, the recognised leader in moving light technology, has made another major leap in innovation. The new ESPRITE® Profile LED automated luminaire has a fast-change, low-cost, transferable light engine ingeniously solving the problem of performance longevity for those preferring the higher brightness of white source LEDs as an obvious replacement for their aging stock of discharge workhorses.

With our unique, ground-breaking TRANSFERABLE ENGINE technology, we offer a selection of engines. The TE™ 650W HP White LED Engine (HP - High Performance) maximizes output, while the TE™ 650W HCF White LED Engine (HCF - High Colour Fidelity) ensures exceptional colour rendition. Additionally, the TE™ 650W TGW White LED Engine (TGW – Tungsten White) simulates the comforting warmth of tungsten lighting.

Now you can fit either engine within the same fixture, without alignment or warranty issues, within five minutes! Without the expense, and complication of needing to have separate luminaires with differing sources, TRANSFERABLE ENGINES give you the right engine, in the right fixture, at the right time!

The revolutionary self-referencing, data capturing engines are all designed, developed and manufactured within our own factory (Patents pending). Performance remains uncompromised with the TE™ 650W HP White 6.700 K LED Engine producing a piercing 34.000 lm, while the TE™ 650W HCF White 6.000 K LED Engine offers 23.000 lm with an exceptional inherent CRI of 96. The TE™ 650W TGW White 3.200 K LED Engine generates 19.500 lm with a CRI of 97, all measurements being integrating sphere. The L70/B50 ratings of 50.000 hours assure longevity.

This is enhanced by our legendary precision optics to produce crystal clear white light. The comprehensive feature set includes: Flat field CMY mixing; variable CTO; remotely selectable CRI 70/80/90 (HP Engine); two fast colour wheels; rotating and static gobo wheels; 6-facet rotating prism; 1° soft edge and 5° even wash frosts; an animation wheel and spectacular multi-colour effects. Quick, accurate, easy framing is provided via our patented fast framing shutter module with individual blade control and +/-60° rotation capability for extra fine control. The ESPRITE® Profile by design removes any airflow over the optics, resulting in reduced residue deposits thus extending periods between cleaning.

Furthermore, the unique Hot-Spot feature allows you to move from a flat field beam to a 6:1 ratio hot-spot beam giving uniform intensity when overlaying beam edges to create smooth washes of light. The Cpulse™ flicker-free management system operates beautifully with the latest HD and UHD camera systems. ChromaTint™ gives full green/magenta content control, with L3™ Low Light Linearity dimming for ultra-smooth fade to black for seamless integration into traditional lighting rigs.

The ESPRITE® FS is equipped with the digital camera on the head and can be connected with the RoboSpot™ BaseStation for off-stage follow spot operation.seamless integration with traditional lighting rigs.

Source

- Light source type: **TE™ 650W HP White LED Engine** (Patented)
 - HP - High Performance Engine for maximum light output and optimal colour characteristics
 - LED Engine output: 35.000 lm
 - Fixture total lumen output: 34.000 lm (integrated sphere) 27.000 lm (goniophotometer)
 - Colour temperature output: 6.700K
 - CRI: 70, remotely selectable filters for CRI 80 and CRI 90
 - Illuminance: 85.000 lx @ 5 m
- Light source type: **TE™ 650W HCF White LED Engine** (Patented)
 - HCF - High Colour Fidelity Engine for the best light quality and colour rendition
 - LED Engine output: 37.500 lm
 - Fixture total lumen output: 22.800 lm (integrated sphere) 18.300 lm (goniophotometer)
 - Colour temperature output: 6.000K
 - CRI: 96, TLCI: 97, TM-30-18 Rf: 92, TM-30-18 Rg: 99
 - Illuminance: 59.000 lx @ 5 m
- Light source type: **TE™ 650W TGW White LED Engine** (Patented)
 - TGW - Simulates the comforting warmth of tungsten lighting
 - LED Engine output: 30.250 lm
 - Fixture total lumen output: 19.500 lm (integrated sphere) 15.700 lm (goniophotometer)
 - Colour temperature output: 3.200K
 - CRI: 97, TLCI: 97, TM-30-18 Rf: 93, TM-30-18 Rg: 102
 - Illuminance: 50.000 lx @ 5 m
- LED life expectancy: min. 50.000 hours
- Typical lumen maintenance: L70/B50 @ 50.000 hours
- Light source warranty: 4 years or 20.000 hours

- Rotating gobo wheel: 7 rotating, indexable and replaceable breakup and aerial gobos + open, patented slot & lock system
- Static gobo wheel: 9 static and replaceable gobos + open
- Animation wheel: Aluminium animation wheel, used alone or in combination with gobos, rotating in both directions at variable speed
- Prism: 6-facet prism rotating in both directions at variable speed
- Iris: Motorized, stepless, pulse effects up to 3 Hz
- MagFrost™ - magnetic paddle fast change system providing exchangeable frosts containing as standard a very light 1° for instant softening of the projected gobo or framing shutters, and a medium 5° for even wash, both specifically selected for theatre and TV use
- Hot-Spot: from flat field to 6:1 hot-spot
- Motorized zoom and focus
- Electronic strobe effect with variable speed up to 20 Hz
- High resolution electronic dimming: 0–100%
- L3™ - (Low Light Linearity) Imperceptible 18 bit dimming for ultra smooth fade to black
- Cpulse™ - special flicker free management for HD and UHD cameras, ready for 8K and 16K
- AirLOC™ - (Less Optical Cleaning) technology greatly reduces the level of airborne particles drawn over the optical elements. This increases the overall performance, light quality and time between routine cleaning and maintenance.

- Animation wheel rotation: 8 bit
- Iris: 8 or 16 bit
- Frost: 8 bit
- Zoom: 8 or 16 bit
- Focus: 8 or 16 bit
- Dimmer: 8 or 16 bit (internal 18 bit)

Movement

- Pan movement: 540°
- Tilt movement: 265°
- Movement control: Standard and Speed
- EMS™ - Electronic Motion Stabilizer system for Pan & Tilt reducing beam deviation caused by truss movement or vibration (Patented)
- Automatic Pan & Tilt position correction

Rotating Gobos

- 7x rotating glass gobos
- Outside diameter: 26.8 mm
- Image diameter: 23.5 mm
- Thickness: 1.1 mm
- Max. thickness: 3.5 mm
- High temperature borofloat or better glass
- Patented slot & lock system for easy replacement of gobos

Static Gobos

- 9x static glass gobos
- Outside diameter: 26.8 mm
- Image diameter: 23.5 mm
- Thickness: 1.1 mm
- Max. thickness: 3.5 mm
- High temperature borofloat or better glass

Effect Wheel

- Single animation wheel
- Material: Aluminium
- Can be used alone or in combination with rotating gobos
- Rotating in both directions, variable speed

Framing Shutters System

- Patented Plano4™ framing shutters module
- 4 Blades, each with separate movement and rotation control
- Smooth movement with variable speed control ultrafast blade movements for creating mid-air effects
- Pre-programmed Shape and blade sequences
- Rotation +/- 60° of the complete framing system

Camera - ESPRITE FS

- Type: XNZ-L6320A
- Resolution: 1920 x 1080, 16:9 Full HD (1080p) resolution support
- Zoom: 32x optical zoom 32x digital zoom

Optical System

- Robe's proprietary optical design
- High-efficiency 13-lens zoom optical system, ratio 9:1
- Zoom range: 5.5° - 50°
- Output lens diameter: 150 mm

Dynamic Effects and Features

- Cyan: 0–100%
- Magenta: 0–100%
- Yellow: 0–100%
- Variable CTO: 3.000K - 6.700K
- ChromaTint™ - Patented plus / minus green correction function
- Colour Wheel 1: 5 fixed dichroic colours + white
- Colour Wheel 2: 5 fixed dichroic colours + white
- Framing shutters: Patented Plano4™ framing shutters module with 4 individually positionable blades plus rotation of the complete frame system +/-60°

Control and Programming

- Setting & Addressing: ROBE Navigation System 2 (RNS2)
- Display: QVGA Robe touch screen with battery backup, gravitation sensor for auto screen positioning, operation memory service log with RTC, stand-alone operation with 2 editable programs (each up to 80 steps), built-in analyser for easy fault finding
- Protocols: USITT DMX-512, RDM, ArtNet, MA Net, MA Net2, sACN
- REAP™ - Robe Ethernet Access Portal
- Wireless CRMX™ technology from Lumen Radio - on request
- Epass™ - Ethernet pass through switch which sustains Ethernet integrity, when the fixture has no power, to automatically maintain network connectivity - on request
- DMX Protocol modes: 4
- Control channels: 49, 42, 50, 43
- Pan & Tilt resolution: 16 bit
- CMY & CTO: 8 bit
- + - Green correction: 8 bit
- Colour wheel positioning: 8 or 16 bit
- Framing shutters module movement & rotation: 8 bit
- Rotating gobo wheel positioning: 8 bit
- Gobo indexing & rotation: 8 or 16 bit
- Static gobo wheel positioning: 8 bit
- Animation wheel: 8 bit



- Streaming: H.265, H.264, MJPEG Codec, Multiple streaming
- Vision: Day & Night (ICR), WDR (120dB)
- Minimum illumination: 0.05 Lux

Thermal Specification

- Maximum ambient temperature: 45 °C (113 °F)
- Maximum surface temperature: 80 °C (176 °F)
- Minimum operating temperature: -5 °C (23 °F)
- Total heat dissipation: max. 2430 BTU/h (calculated)

Noise Levels

- Sound pressure level: 27 dB(A) at 1 m (quiet mode)
42 dB(A) at 1 m (auto mode)
- Sound power level: 35 dB(A) (quiet mode)
50 dB(A) (auto mode)

Electrical Specification and Connections

- Power supply: Electronic auto-ranging
- Input voltage range: 100-240 V, 50/60 Hz
- Power consumption: Standard mode max. 870 W at 230 V / 50 Hz
High-power mode max. 950W at 230 V / 50 Hz
- Power connector in: Neutrik powerCON TRUE1
- DMX and RDM data in/out: Locking 3-pin & 5-pin XLR
- Ethernet port in: RJ45 - ESPRITE Profile
- Ethernet port in: RJ45 - ESPRITE FS, camera video output
- Ethernet port in/out: RJ45 (instead of 3-pin XLR) - ESPRITE Profile & FS, for Embedded Epass® switch 10/100 Mbps - on request
- USB connector (series A) for lightmaster purposes

Approvals

- CE Compliant
- cETLus Compliant

Environmental Information

ESPRITE

- GWP (Global Warming Potential) total in modules A1-A3 (according LCA): 755 Kg CO2e
- EPD registration number: EPD-IES-0011284:002 (S-P-11284)

Mechanical specification

- Height: 733 mm (28.9")
- Width: 443 mm (17.4")
- Depth: 264 mm (10.4") - head in vertical position
- Weight: ESPRITE 28.2 kg (62.2 lbs)
ESPRITE FS 29.4 kg (64.8 lbs)
- Ingress protection rating: IP20

Rigging

- Mounting positions: Horizontally or vertically
- Universal operating position
- Mounting points: 5 pairs of 1/4-turn locking points
- 2x Omega adaptors with 1/4-turn quick locks
- Safety cable attachment point
- Pan & Tilt transport locks

Included Items

- User Manual
- Omega Adaptor CL-regular 2 pcs



- Power cord including powerCON TRUE1 In connector
- RoboSpot Camera for ESPRITE FS

Optional Accessories

- Esprite TE™ 650W HP White LED Engine: 14080066
- Esprite TE™ 650W HCF White LED Engine: 14080071
- Esprite TE™ 650W TGW White LED Engine: 14080079
- Frost 0.5° (exchange) assembled: 10980583
- Frost 10° (exchange) assembled: 10980497
- Frost 20° (exchange) assembled: 10980574
- Frost 30° (exchange) assembled: 10980584
- FS BMFL/ESPRITE/FORTE Handles - 2 pcs in box: 10980233
- Hot-Spot lens in gobo holder: 10980483
- Gel frame adaptor: 10980463

- Gel frame: 10980464
- Doughty Trigger Clamp: 17030386
- Omega Adaptor Tall CL-regular 2 pcs in box: 10980501
- Safety wire 35 kg: 99011963
- Upgrade kit CRMX Universal 260: 99030100
- Single Top Loader Case: 10120254
- Dual Top Loader Case: 10120255
- Foam Shell: 20020357
- Top Hat: 10980568

Legal

- ESPRITE® is Registered Trademark of Robe lighting s. r. o.
- ESPRITE® and ESPRITE® FS are patented by Robe lighting s. r. o. and protected by one or more pending or issued patents

Colour Wheel 1



Colour Wheel 2



Static Gobo Wheel



Rotating Gobo Wheel

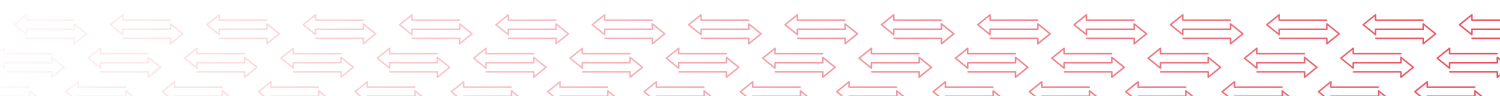

Framing Shutters Module

ESPRITE® uses Robe's patented Plano4™ system of four, fast, smooth moving, shutter blades, which can be individually angled and positioned. The whole module assembly can further rotate +/- 60 degrees. Thanks to the unique design, all four blades can be focused at the same time and can be further softened by applying a light 1° frost giving the edges soft diffusion which is required in TV and Theatres. Shutters are precisely calibrated in the factory to ensure maximum accuracy and repeatability of programmed framing shapes.

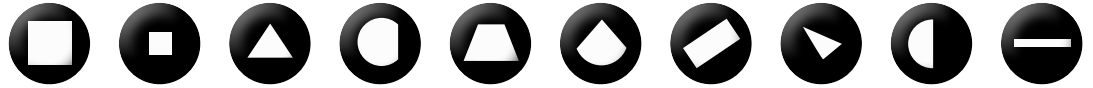
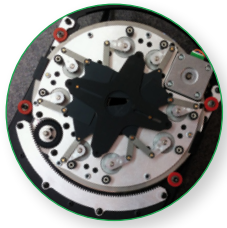

Impressive Aerial and Graphic Effects

ESPRITE® will excite you with numerous possibilities for animations and mid-air effects thanks to two gobo wheels with carefully selected break-up and aerial gobos which can be further combined with a 6-facet rotating prism, animation wheel, split colours and a special multi-colour filter. By using these features, you will achieve interesting animations and effects like clouds, rain, water, fire and more abstract morphing images.

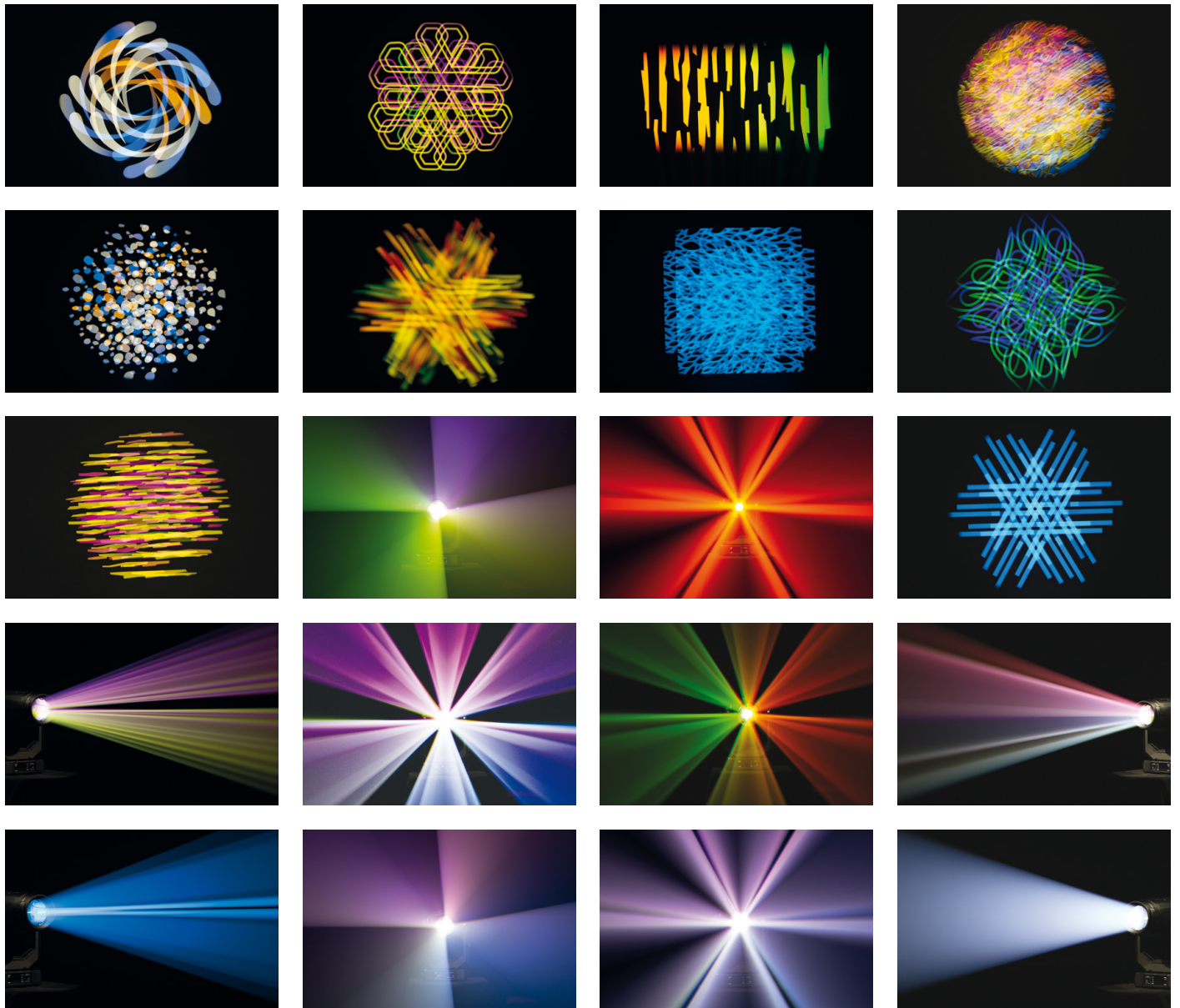

ESPRITE HP

Photometric report

Beam angle 5.5° - Min. zoom - CRI 70

Beam angle	Total lumen output (integrating sphere)	Total lumen output (goniophotometer)	Peak candela	Power
5.5°	16711 lm	15915 lm	2114750 cd	940 W

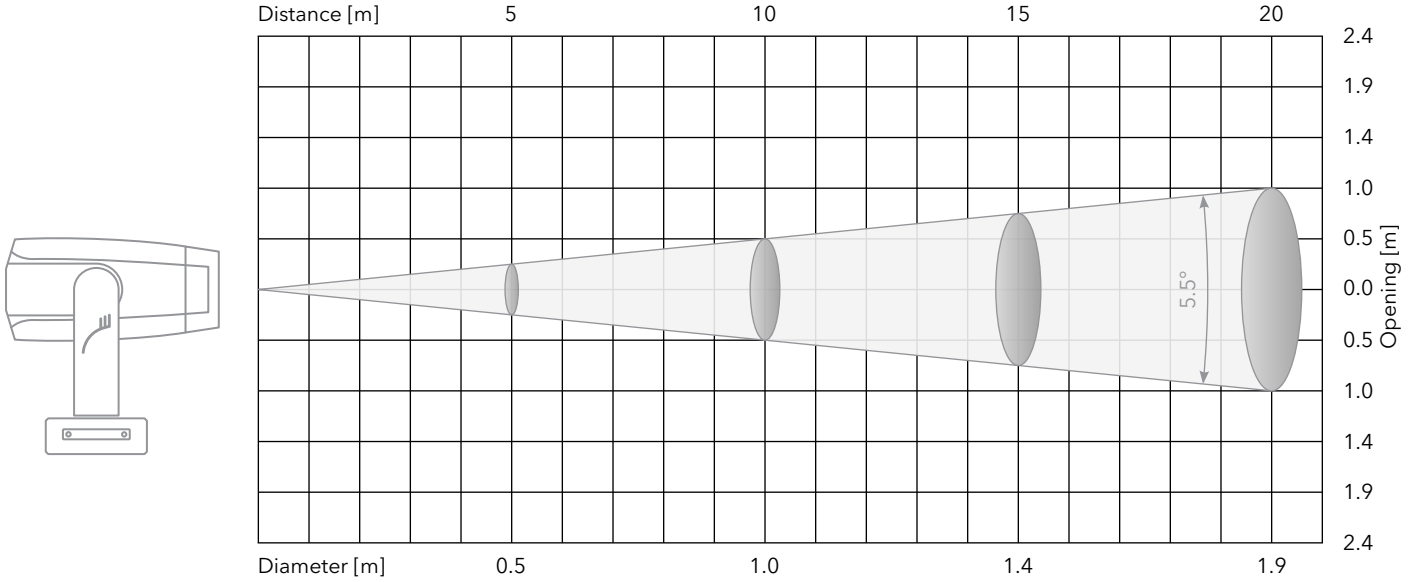

Center beam intensity [lx]/[fcd]; Total lumen output [lm] measured by goniophotometer

Distance	5 m	10 m	15 m	20 m	30 m	40 m	50 m	Total lumens
High-Power Mode	84590/7859	21148/1965	9399/873	5287/491	2350/218	1322/123	846/79	15915
Auto Fan Mode	75010/6969	18753/1742	8334/774	4688/436	2084/194	1172/109	750/70	14113
High Fan Mode	79800/7414	19950/1853	8867/824	4988/463	2217/206	1247/116	798/74	15014
Quiet Fan Mode	55081/5117	13770/1279	6120/569	3443/320	1530/142	861/80	551/51	10363

Spectrum

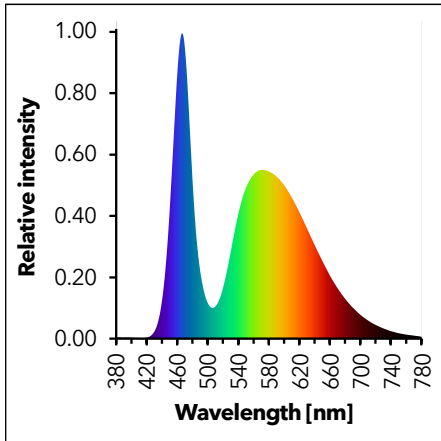

TM-30

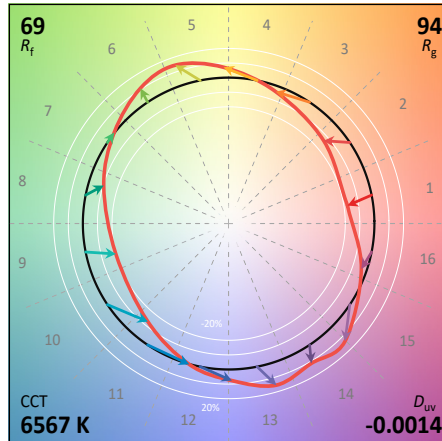

Light distribution

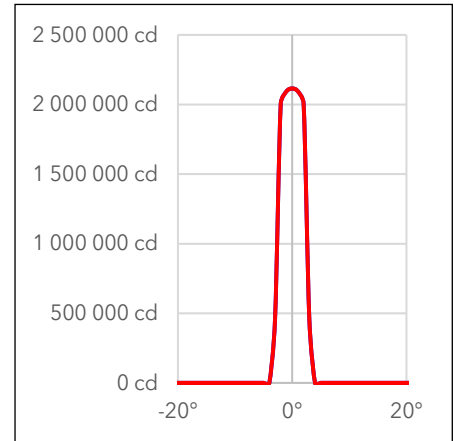

Color temperature	CCT	6567 K
Color Deviation from Black	Duv	-0.0014
Color Coordinate CIE 1931	x	0.3128
	y	0.3203
Color Coordinate	u	0.2012
	v	0.3091

Color rendering index	CRI	70
Red component	CRI R9	-24
Color fidelity	TM30 Rf	69
Color gamut	TM30 Rg	94
Television consistency Index	TLCI	44

Fixture settings: DMX mode: 1; Fans: High Power Mode; Dimmer curve: Square Law; Shutter: Open; Dimmer: Open; No effect in light beam
Measurement date: 12.04.2024

ESPRITE HP

Photometric report

Beam angle 5.5° - Min. zoom - CRI 80

Beam angle	Total lumen output (integrating sphere)	Total lumen output (goniophotometer)	Peak candela	Power
5.5°	13246 lm	12615 lm	1676250 cd	940 W

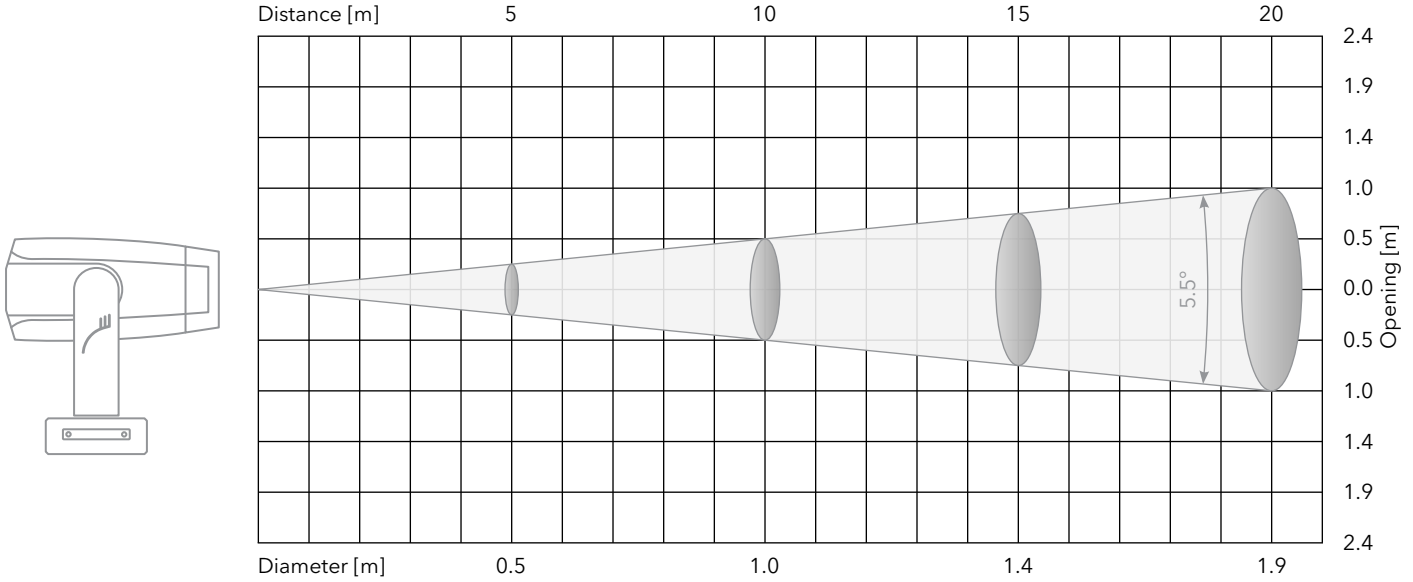

Center beam intensity [lx]/[fcd]; Total lumen output [lm] measured by goniophotometer

Distance	5 m	10 m	15 m	20 m	30 m	40 m	50 m	Total lumens
High-Power Mode	67050/6229	16763/1557	7450/692	4191/389	1863/173	1048/97	671/62	12615
Auto Fan Mode	59456/5524	14864/1381	6606/614	3716/345	1652/153	929/86	595/55	11186
High Fan Mode	63253/5876	15813/1469	7028/653	3953/367	1757/163	988/92	633/59	11901
Quiet Fan Mode	43659/4056	10915/1014	4851/451	2729/254	1213/113	682/63	437/41	8214

Spectrum

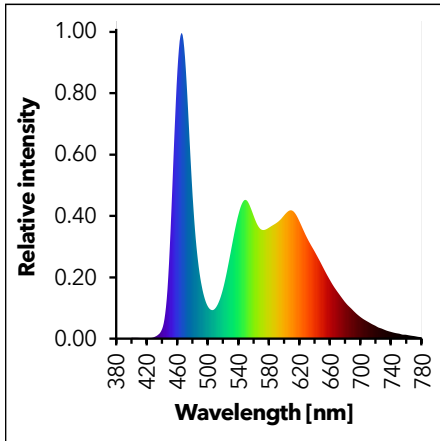

TM-30

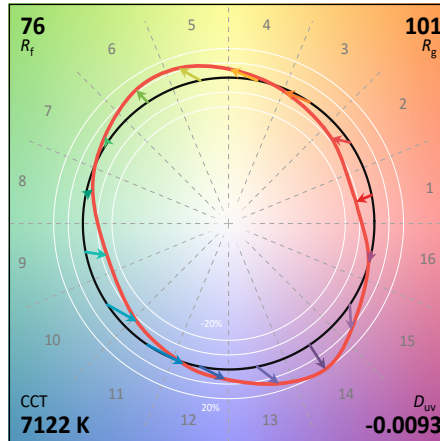

Light distribution

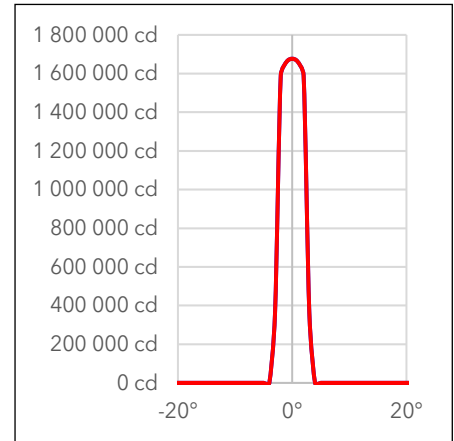

Color temperature	CCT	7122 K
Color Deviation from Black	D_{uv}	-0.0093
Color Coordinate CIE 1931	x	0.3079
	y	0.3009
Color Coordinate	u	0.2054
	v	0.3011

Color rendering index	CRI	81
Red component	CRI R9	21
Color fidelity	TM30 R_f	76
Color gamut	TM30 R_g	101
Television consistency Index	TLCI	60

Fixture settings: DMX mode: 1; Fans: High Power Mode; Dimmer curve: Square Law; Shutter: Open; Dimmer: Open; No effect in light beam
Measurement date: 12.04.2024

ESPRITE HP

Photometric report

Beam angle 5.5° - Min. zoom - CRI 90

Beam angle	Total lumen output (integrating sphere)	Total lumen output (goniophotometer)	Peak candela	Power
5.5°	11576 lm	11025 lm	1465000 cd	940 W

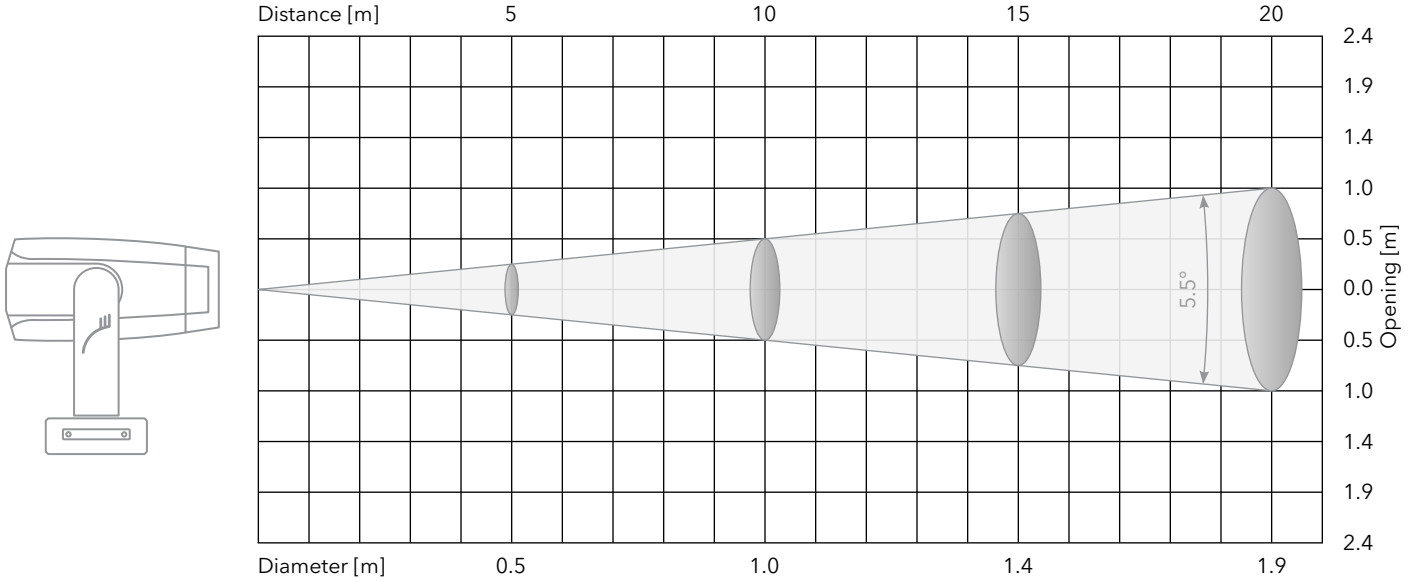

Center beam intensity [lx]/[fcd]; Total lumen output [lm] measured by goniophotometer

Distance	5 m	10 m	15 m	20 m	30 m	40 m	50 m	Total lumens
High-Power Mode	58600/5444	14650/1361	6511/605	3663/340	1628/151	916/85	586/54	11025
Auto Fan Mode	51963/4828	12991/1207	5774/536	3248/302	1443/134	812/75	520/48	9776
High Fan Mode	55282/5136	13821/1284	6142/571	3455/321	1536/143	864/80	553/51	10401
Quiet Fan Mode	38157/3545	9539/886	4240/394	2385/222	1060/98	596/55	382/35	7179

Spectrum

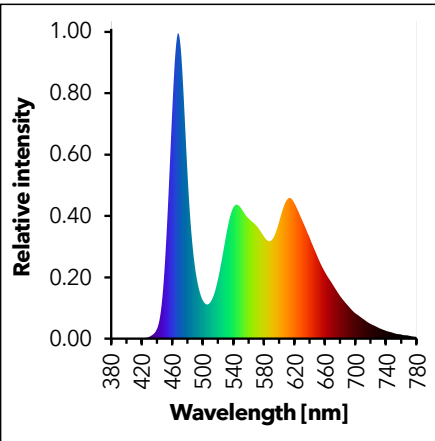

TM-30

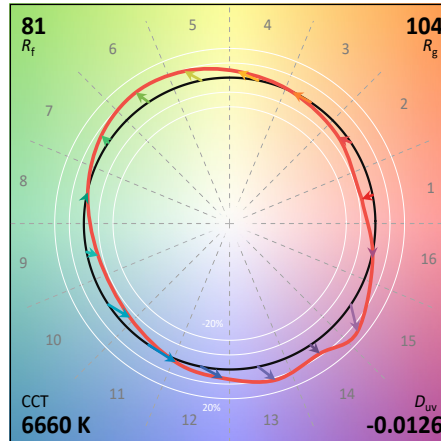

Light distribution

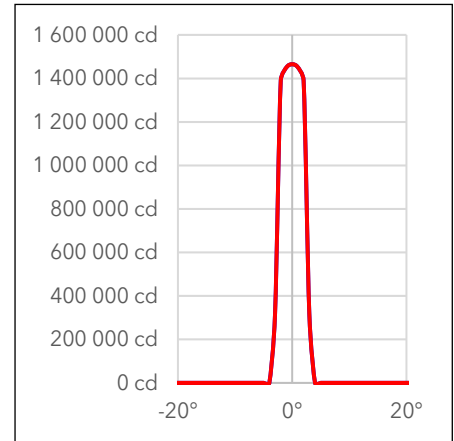

Color temperature	CCT	6660 K
Color Deviation from Black	D_{uv}	-0.0126
Color Coordinate CIE 1931	x	0.3143
	y	0.3014
Color Coordinate	u	0.2099
	v	0.3020

Color rendering index	CRI	87
Red component	CRI R9	47
Color fidelity	TM30 R_f	81
Color gamut	TM30 R_g	104
Television consistency Index	TLCI	70

Fixture settings: DMX mode: 1; Fans: High Power Mode; Dimmer curve: Square Law; Shutter: Open; Dimmer: Open; No effect in light beam
Measurement date: 12.04.2024

ESPRITE HP

Photometric report

Field angle 50° - Max. zoom - CRI 70

Field angle	Total lumen output (integrating sphere)	Total lumen output (goniophotometer)	Peak candela	Power
50°	33638 lm	26910 lm	51250 cd	940 W

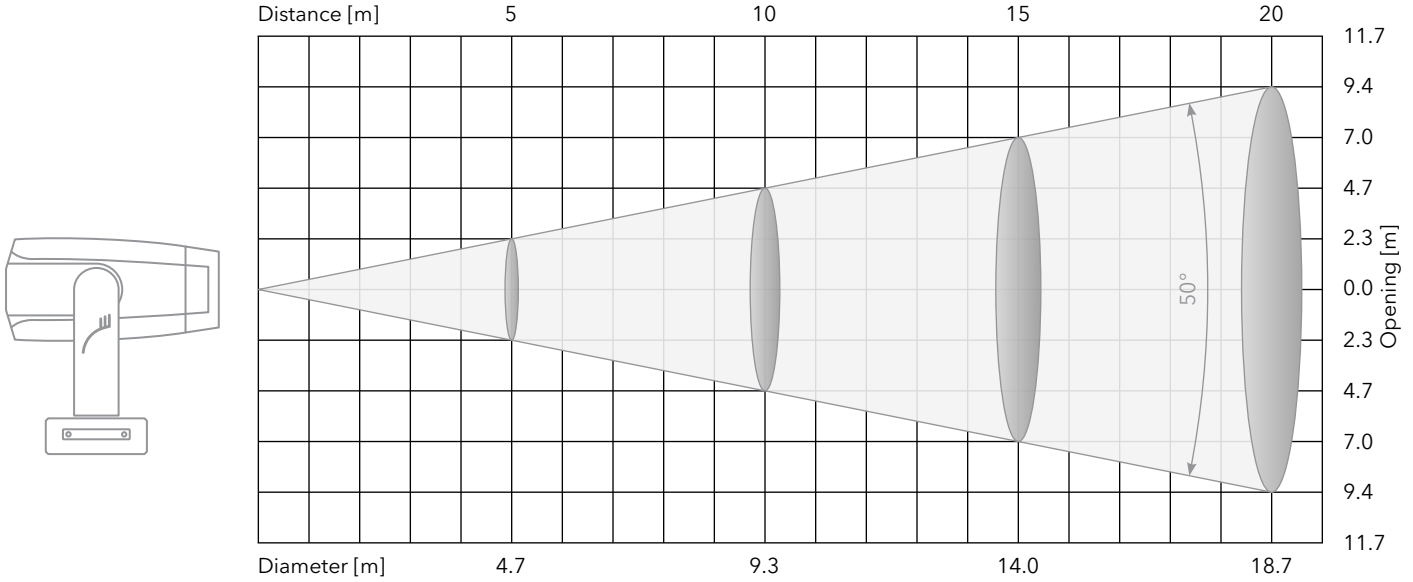

Center beam intensity [lx]/[fcd]; Total lumen output [lm] measured by goniophotometer

Distance	5 m	10 m	15 m	20 m	30 m	40 m	50 m	Total lumens
High-Power Mode	2050/190	513/48	228/21	128/12	57/5	32/3	21/1.9	26910
Auto Fan Mode	1823/169	456/42	203/19	114/11	51/4.7	28/2.6	18/1.7	23930
High Fan Mode	1940/180	485/45	216/20	121/11	54/5	30/2.8	19/1.8	25466
Quiet Fan Mode	1339/124	335/31	149/14	84/8	37/3.5	21/1.9	13/1.2	17577

Spectrum

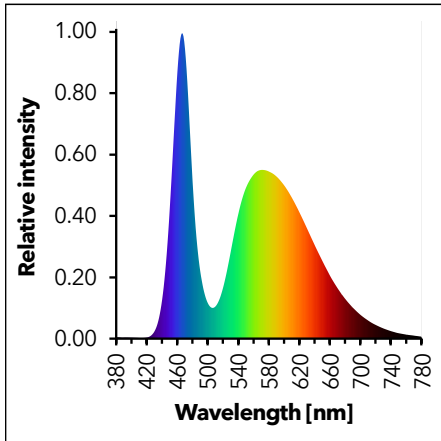

TM-30

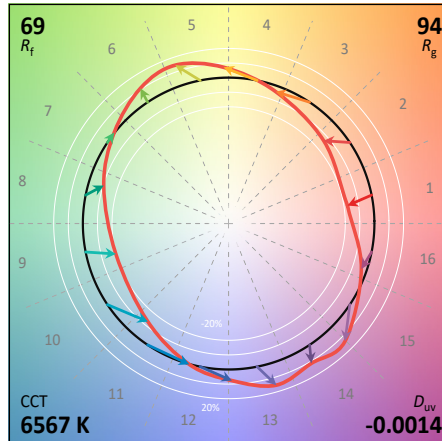

Light distribution

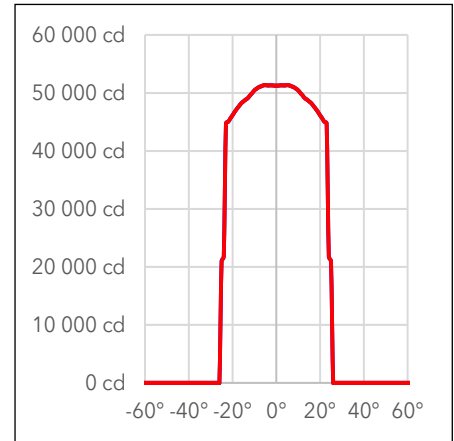

Color temperature	CCT	6567 K
Color Deviation from Black	D_{uv}	-0.0014
Color Coordinate CIE 1931	x	0.3128
	y	0.3203
Color Coordinate	u	0.2012
	v	0.3091

Color rendering index	CRI	70
Red component	CRI R9	-24
Color fidelity	TM30 Rf	69
Color gamut	TM30 Rg	94
Television consistency Index	TLCI	44

Fixture settings: DMX mode: 1; Fans: High Power Mode; Dimmer curve: Square Law; Shutter: Open; Dimmer: Open; No effect in light beam
Measurement date: 12.04.2024

ESPRITE HP

Photometric report

Field angle 50° - Max. zoom - CRI 80

Field angle	Total lumen output (integrating sphere)	Total lumen output (goniophotometer)	Peak candela	Power
50°	25434 lm	20347 lm	38750 cd	940 W

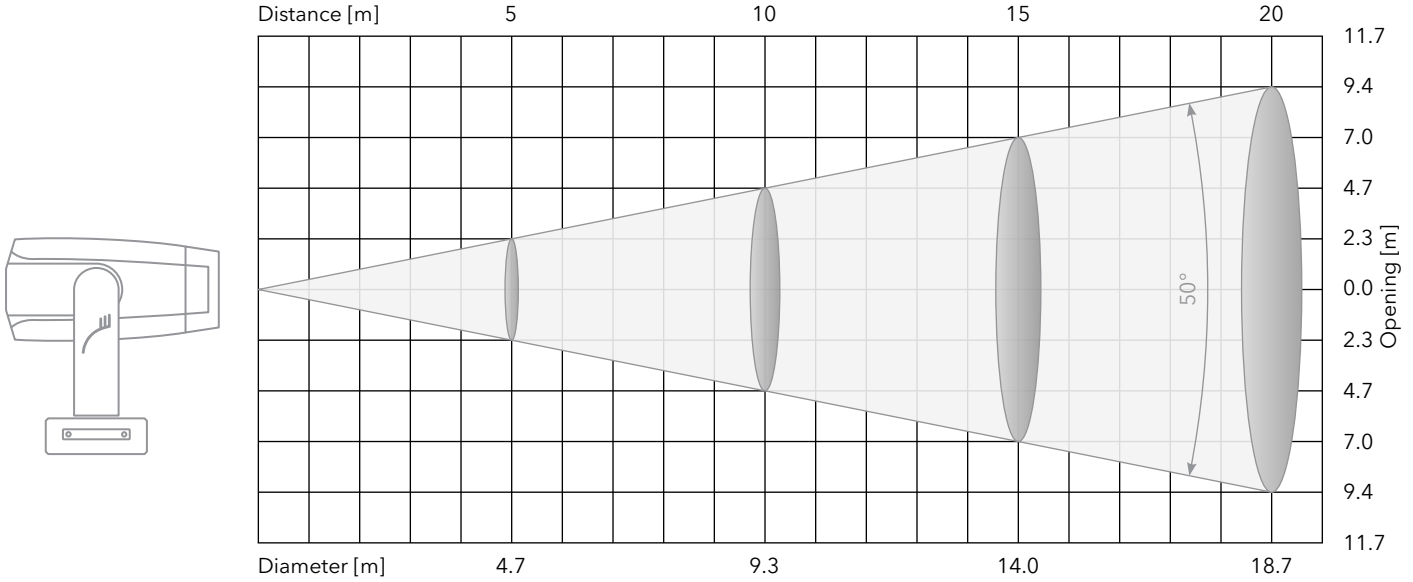

Center beam intensity [lx]/[fcd]; Total lumen output [lm] measured by goniophotometer

Distance	5 m	10 m	15 m	20 m	30 m	40 m	50 m	Total lumens
High-Power Mode	1550/144	388/36	172/16	97/9	43/4	24/2.2	16/1.4	20347
Auto Fan Mode	1378/128	345/32	153/14	86/8	38/3.6	22/2	14/1.3	18089
High Fan Mode	1467/136	367/34	163/15	92/9	41/3.8	23/2.1	15/1.4	19257
Quiet Fan Mode	1012/94	253/24	112/10	63/6	28/2.6	16/1.5	10/0.9	13285

Spectrum

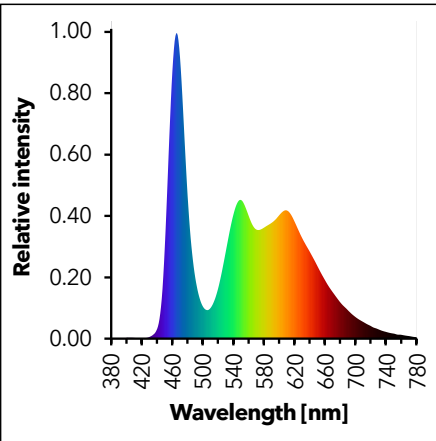

TM-30

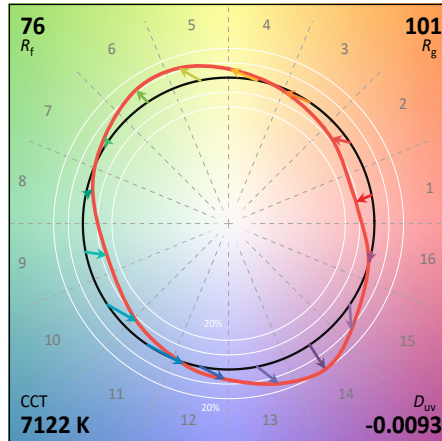

Light distribution

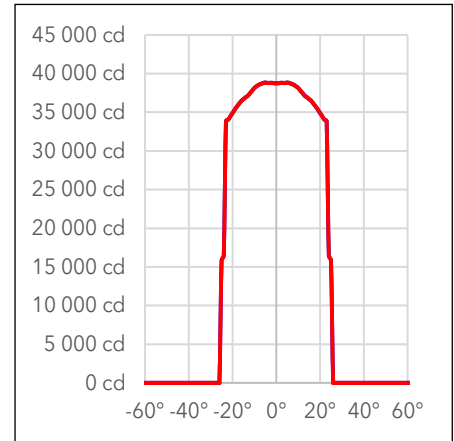

Color temperature	CCT	7122 K
Color Deviation from Black	D_{uv}	-0.0093
Color Coordinate CIE 1931	x	0.3079
	y	0.3009
Color Coordinate	u	0.2054
	v	0.3011

Color rendering index	CRI	81
Red component	CRI R9	21
Color fidelity	TM30 R_f	76
Color gamut	TM30 R_g	101
Television consistency Index	TLCI	60

Fixture settings: DMX mode: 1; Fans: High Power Mode; Dimmer curve: Square Law; Shutter: Open; Dimmer: Open; No effect in light beam
Measurement date: 12.04.2024

ESPRITE HP

Photometric report

Field angle 50° - Max. zoom - CRI 90

Field angle	Total lumen output (integrating sphere)	Total lumen output (goniophotometer)	Peak candela	Power
50°	22973 lm	18378 lm	35000 cd	940 W

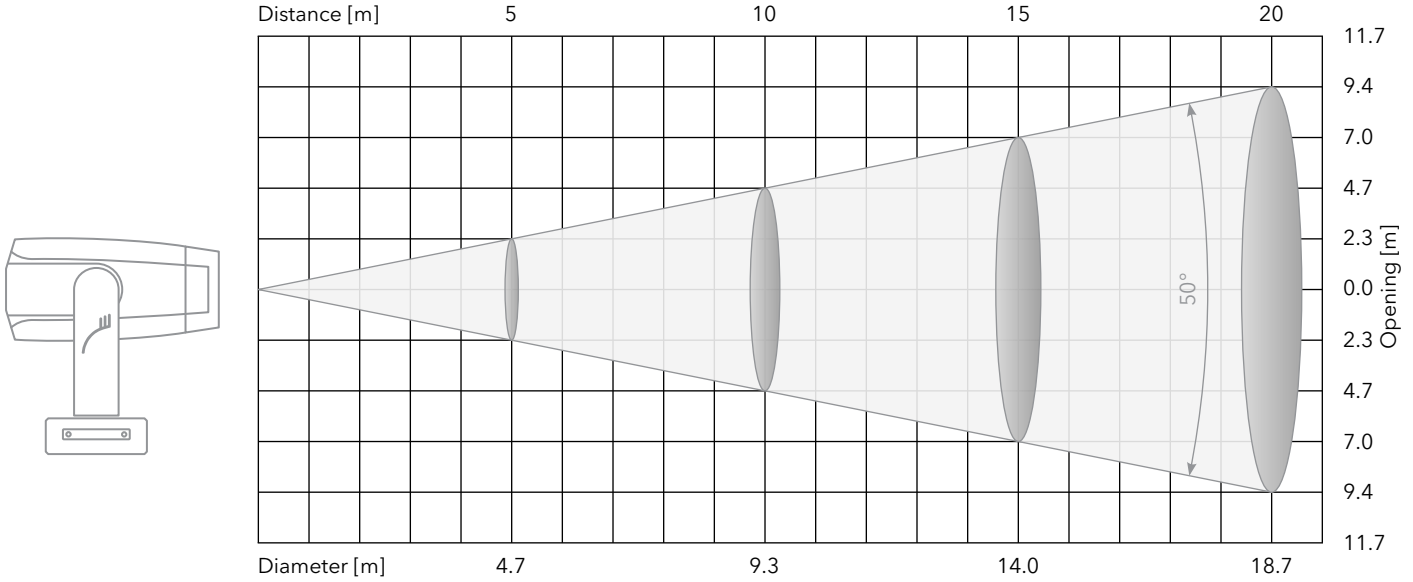

Center beam intensity [lx]/[fcd]; Total lumen output [lm] measured by goniophotometer

Distance	5 m	10 m	15 m	20 m	30 m	40 m	50 m	Total lumens
High-Power Mode	1400/130	350/33	156/14	88/8	39/3.6	22/2	14/1.3	18378
Auto Fan Mode	1245/116	311/29	138/13	78/7	35/3.2	19/1.8	12/1.2	16343
High Fan Mode	1325/123	331/31	147/14	83/8	37/3.4	21/1.9	13/1.2	17393
Quiet Fan Mode	914/85	229/21	102/9	57/5	25/2.4	14/1.3	9/0.8	11998

Spectrum

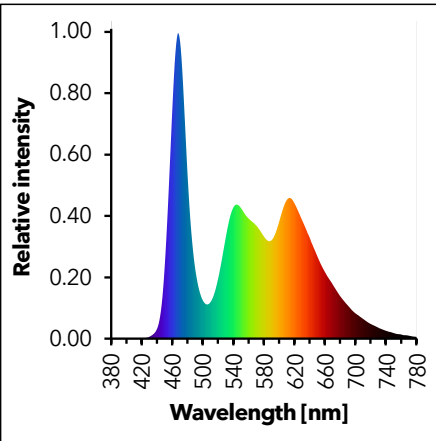

TM-30

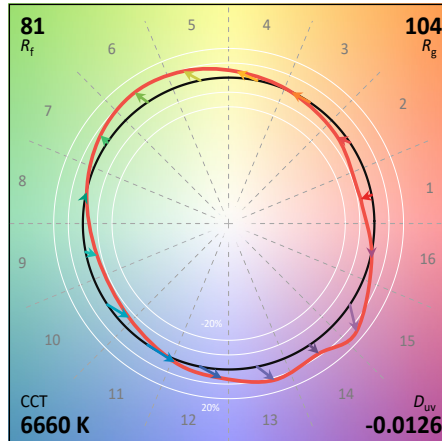

Light distribution

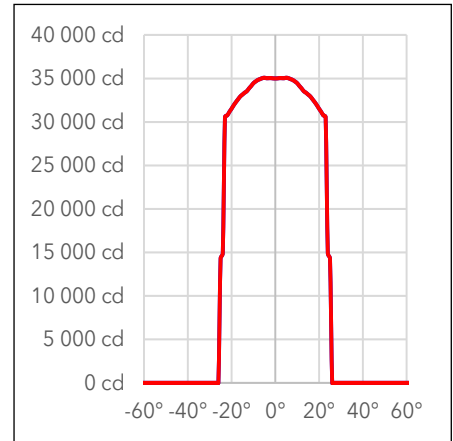

Color temperature	CCT	6660 K
Color Deviation from Black	D_{uv}	-0.0126
Color Coordinate CIE 1931	x	0.3143
	y	0.3014
Color Coordinate	u	0.2099
	v	0.3020

Color rendering index	CRI	87
Red component	CRI R9	47
Color fidelity	TM30 R_f	81
Color gamut	TM30 R_g	104
Television consistency Index	TLCI	70

Fixture settings: DMX mode: 1; Fans: High Power Mode; Dimmer curve: Square Law; Shutter: Open; Dimmer: Open; No effect in light beam
Measurement date: 12.04.2024

ESPRITE HCF

Photometric report

Beam angle 5.5° - Min. zoom

Beam angle	Total lumen output (integrating sphere)	Total lumen output (goniophotometer)	Peak candela	Power
5.5°	11363 lm	10822 lm	1438025 cd	870 W

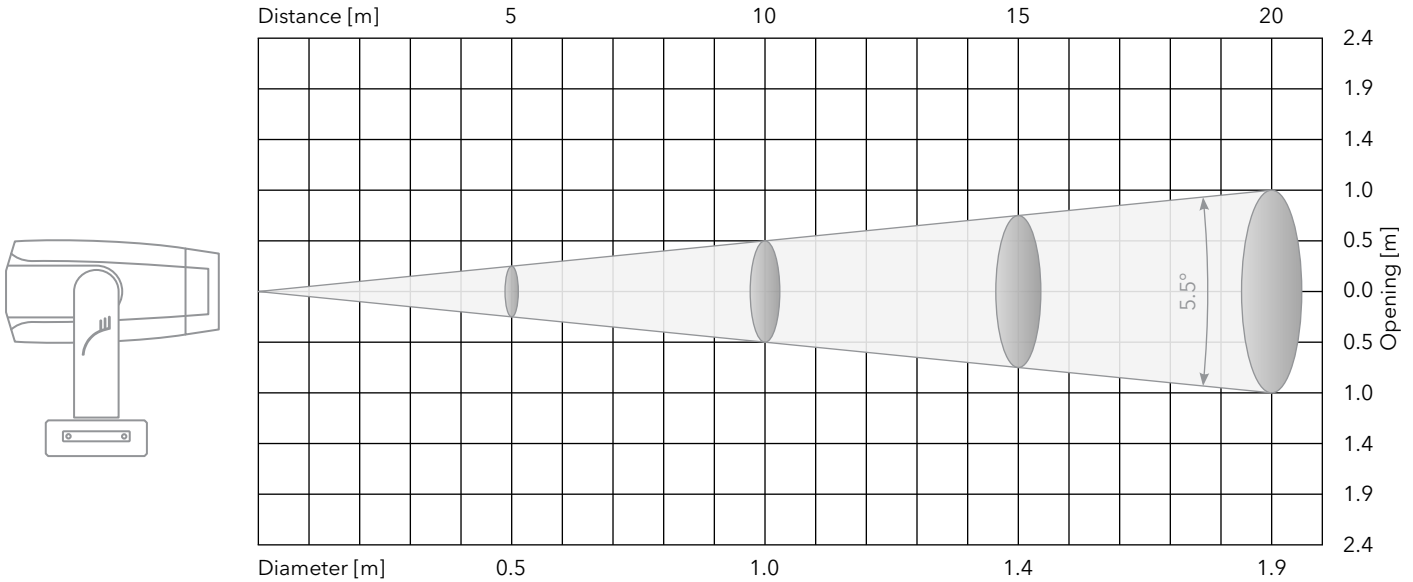

Center beam intensity [lx]/[fcd]; Total lumen output [lm] measured by goniophotometer

Distance	5 m	10 m	15 m	20 m	30 m	40 m	50 m	Total lumens
High-Power Mode	57521/5344	14380/1336	6391/594	3595/334	1598/148	899/83	575/53	10822
Auto Fan Mode	51007/4739	12752/1185	5667/527	3188/296	1417/132	797/74	510/47	9596
High Fan Mode	54264/5041	13566/1260	6029/560	3392/315	1507/140	848/79	543/50	10209
Quiet Fan Mode	37455/3480	9364/870	4162/387	2341/217	1040/97	585/54	375/35	7047

Spectrum

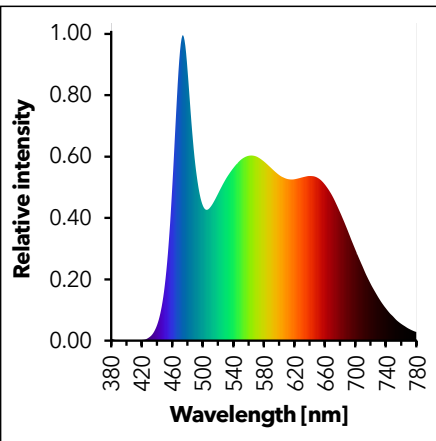

TM-30

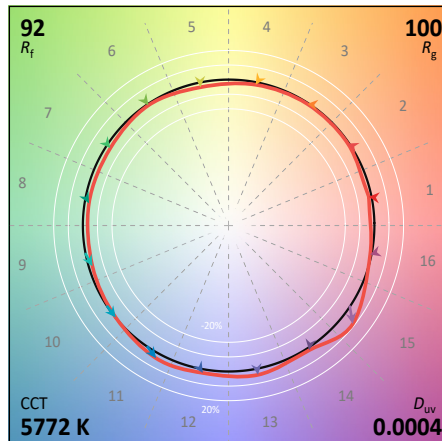

Light distribution

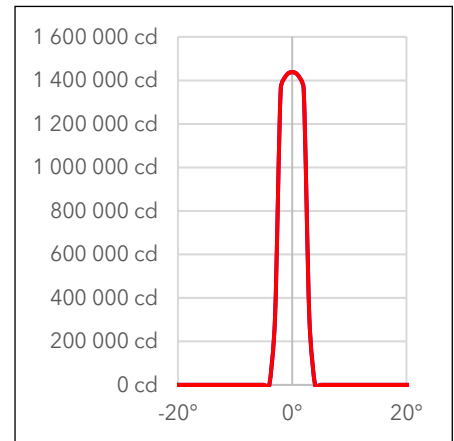

Color temperature	CCT	5772 K
Color Deviation from Black	D_{uv}	0.0004
Color Coordinate CIE 1931	x	0.3265
	y	0.3366
Color Coordinate	u	0.2045
	v	0.3163

Color rendering index	CRI	96
Red component	CRI R9	93
Color fidelity	TM30 R_f	92
Color gamut	TM30 R_g	100
Television consistency Index	TLCI	97

Fixture settings: DMX mode: 1; Fans: High Power Mode; Dimmer curve: Square Law; Shutter: Open; Dimmer: Open; No effect in light beam
Measurement date: 12.04.2024

ESPRITE HCF

Photometric report

Field angle 50° - Max. zoom

Field angle	Total lumen output (integrating sphere)	Total lumen output (goniophotometer)	Peak candela	Power
50°	22874 lm	18299 lm	34850 cd	870 W

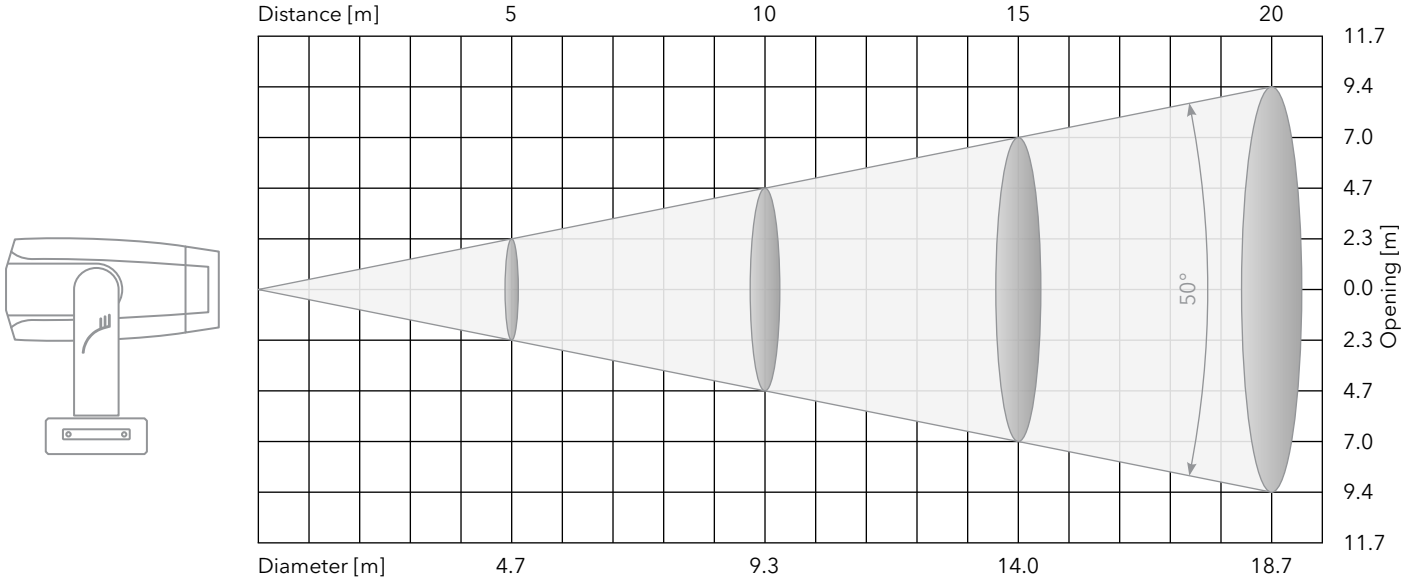

Center beam intensity [lx]/[fcd]; Total lumen output [lm] measured by goniophotometer

Distance	5 m	10 m	15 m	20 m	30 m	40 m	50 m	Total lumens
High-Power Mode	1394/130	349/32	155/14	87/8	39/3.6	22/2	14/1.3	18299
Auto Fan Mode	1240/115	310/29	138/13	78/7	34/3.2	19/1.8	12/1.2	16277
High Fan Mode	1311/122	328/30	146/14	82/8	36/3.4	20/1.9	13/1.2	17209
Quiet Fan Mode	911/85	228/21	101/9	57/5	25/2.4	14/1.3	9/0.8	11959

Spectrum

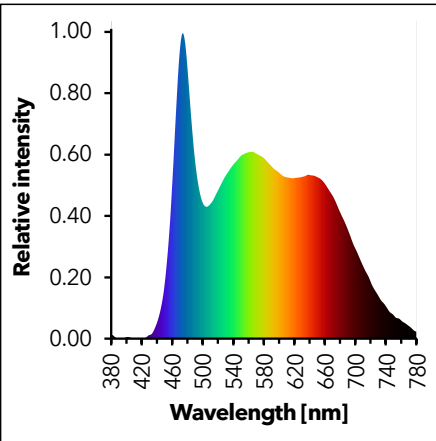

TM-30

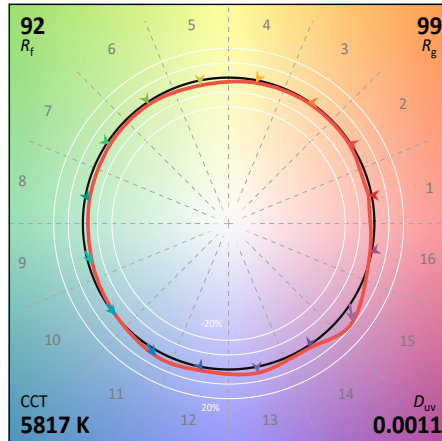

Light distribution

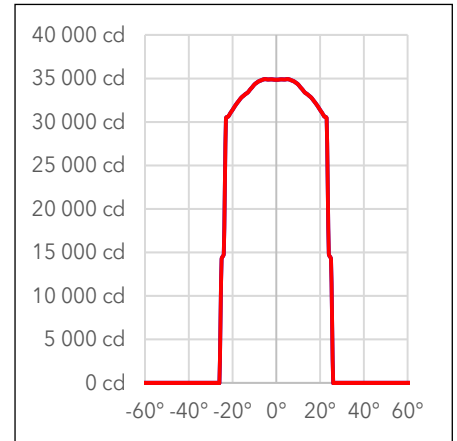

Color temperature	CCT	5817 K
Color Deviation from Black	Duv	0.0011
Color Coordinate CIE 1931	x	0.3255
	y	0.3371
Color Coordinate	u	0.2036
	v	0.3163

Color rendering index	CRI	96
Red component	CRI R9	91
Color fidelity	TM30 Rf	92
Color gamut	TM30 Rg	99
Television consistency Index	TLCI	97

Fixture settings: DMX mode: 1; Fans: High Power Mode; Dimmer curve: Square Law; Shutter: Open; Dimmer: Open; No effect in light beam
Measurement date: 12.04.2024

Esprite TGW

Photometric report

Beam angle 5.5° - Min. zoom

Beam angle	Total lumen output (integrating sphere)	Total lumen output (goniophotometer)	Peak candela	Power
5.5°	9713 lm	9250 lm	1229100 cd	865 W

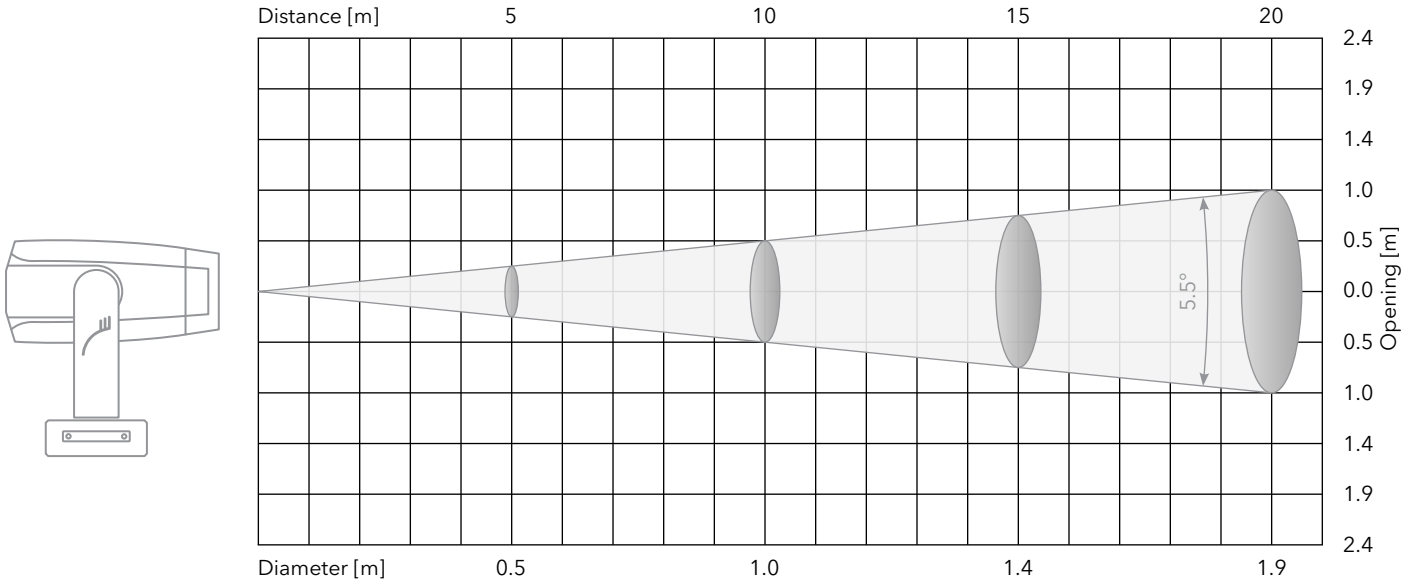

Center beam intensity [lx]/[fcd]; Total lumen output [lm] measured by goniophotometer

Distance	5 m	10 m	15 m	20 m	30 m	40 m	50 m	Total lumens
High-Power Mode	49164/4567	12291/1142	5463/507	3073/285	1366/127	768/71	492/46	9250
Auto Fan Mode	43755/4065	10939/1016	4862/452	2735/254	1215/113	684/64	438/41	8232
High Fan Mode	46214/4293	11554/1073	5135/477	2888/268	1284/119	722/67	462/43	8695
Quiet Fan Mode	32130/2985	8033/746	3570/332	2008/187	893/83	502/47	321/30	6045

Spectrum

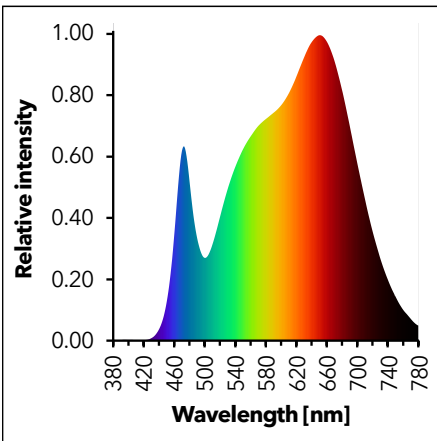

TM-30

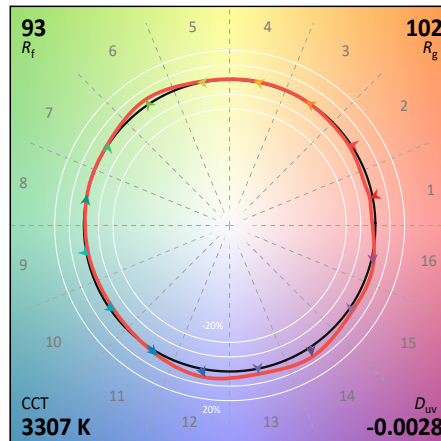

Light distribution

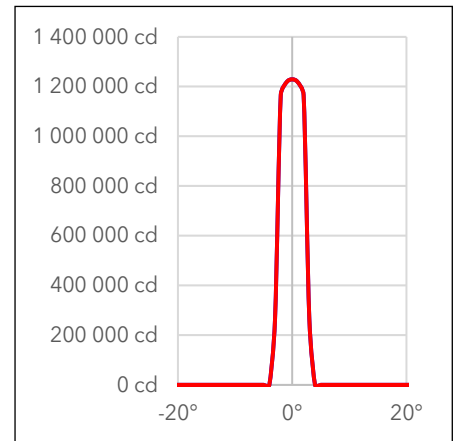

Color temperature	CCT	3307 K
Color Deviation from Black	D_{uv}	-0.0028
Color Coordinate CIE 1931	x	0.4134
	y	0.3882
Color Coordinate	u	0.2420
	v	0.3409

Color rendering index	CRI	96
Red component	CRI R9	87
Color fidelity	TM30 R_f	93
Color gamut	TM30 R_g	102
Television consistency Index	TLCI	96

Fixture settings: DMX mode: 1; Fans: High Power Mode; Dimmer curve: Square Law; Shutter: Open; Dimmer: Open; No effect in light beam
Measurement date: 12.04.2024

Esprite TGW

Photometric report

Field angle 50° - Max. zoom

Field angle	Total lumen output (integrating sphere)	Total lumen output (goniophotometer)	Peak candela	Power
50°	19350 lm	15641 lm	29775 cd	865 W

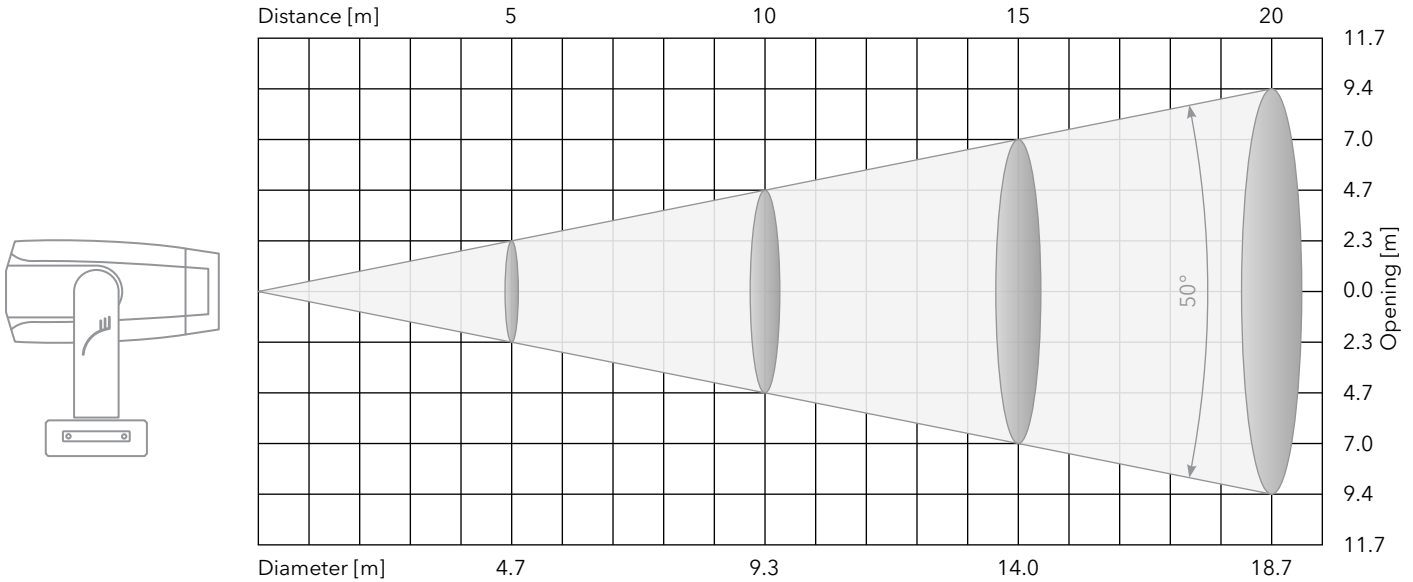

Center beam intensity [lx]/[fcd]; Total lumen output [lm] measured by goniophotometer

Distance	5 m	10 m	15 m	20 m	30 m	40 m	50 m	Total lumens
High-Power Mode	1191/111	298/28	132/12	74/7	33/3.1	19/1.7	12/1.1	15641
Auto Fan Mode	1060/98	265/25	118/11	66/6	29/2.7	17/1.5	11/1	13921
High Fan Mode	1120/104	280/26	124/12	70/7	31/2.9	18/1.6	11/1	14709
Quiet Fan Mode	779/72	195/18	87/8	49/4.5	22/2	12/1.1	8/0.7	10230

Spectrum

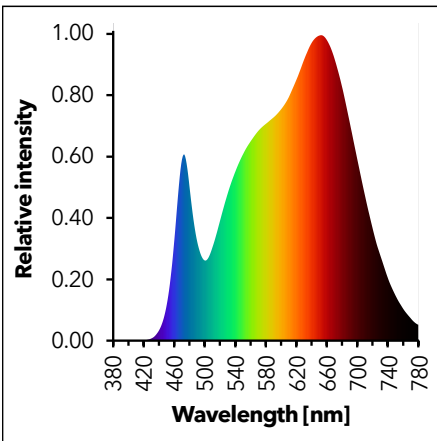

TM-30

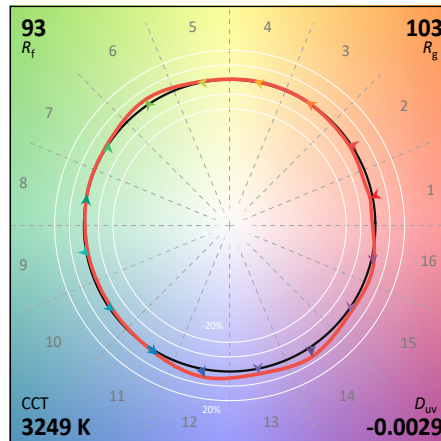

Light distribution

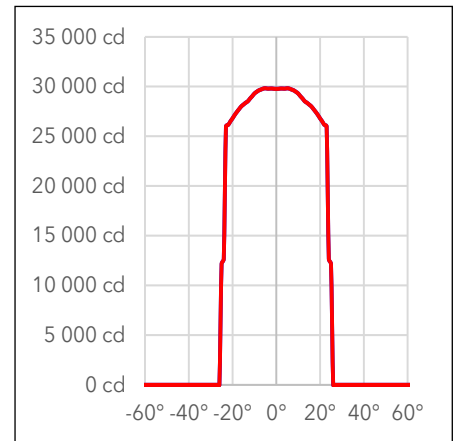

Color temperature	CCT	3249 K
Color Deviation from Black	D_{uv}	-0.0029
Color Coordinate CIE 1931	x	0.4167
	y	0.3893
Color Coordinate	u	0.2437
	v	0.3416

Color rendering index	CRI	96
Red component	CRI R9	88
Color fidelity	TM30 R_f	93
Color gamut	TM30 R_g	103
Television consistency Index	TLCI	96

Fixture settings: DMX mode: 1; Fans: High Power Mode; Dimmer curve: Square Law; Shutter: Open; Dimmer: Open; No effect in light beam
Measurement date: 12.04.2024

Hot-Spot

ESPRITE® Profile produce a beautifully even, flat field of light. Whilst ideal for most applications, the perfect field makes it difficult to achieve smooth, continuous washes of light when the beam edges of multiple fixtures are overlapped.

By introducing our unique, patented, 6:1 ratio Hot-Spot lens, we can alter the field characteristics creating a centre weighted, peaked beam. With the addition of the frost filter, you can now effortlessly achieve silky smooth washes. This exclusive lens further enhances the feature rich ESPRITE® Profile, making it the most versatile Profile available.

Flat field beams without Frost

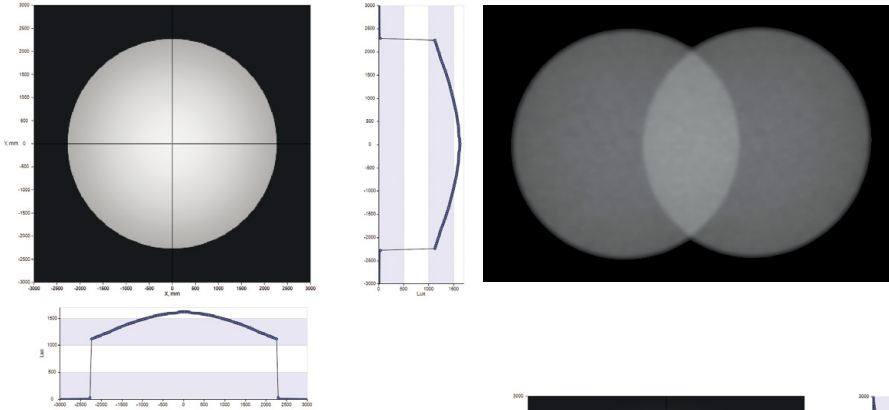

Flat field beams with Frost

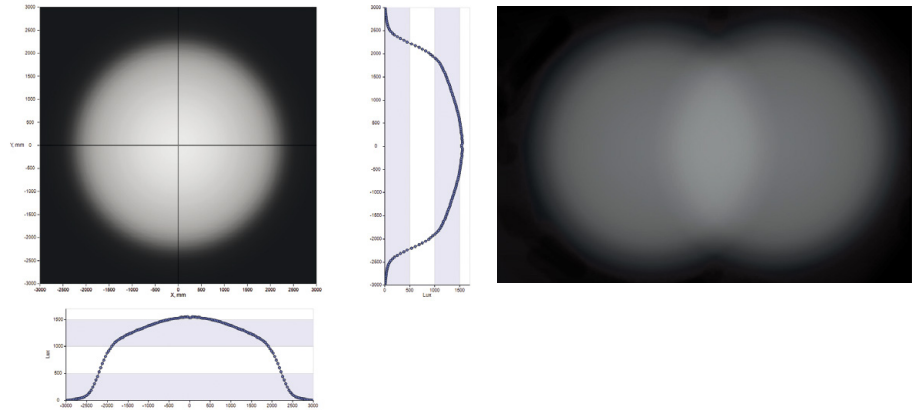

Hot-Spot beams without Frost

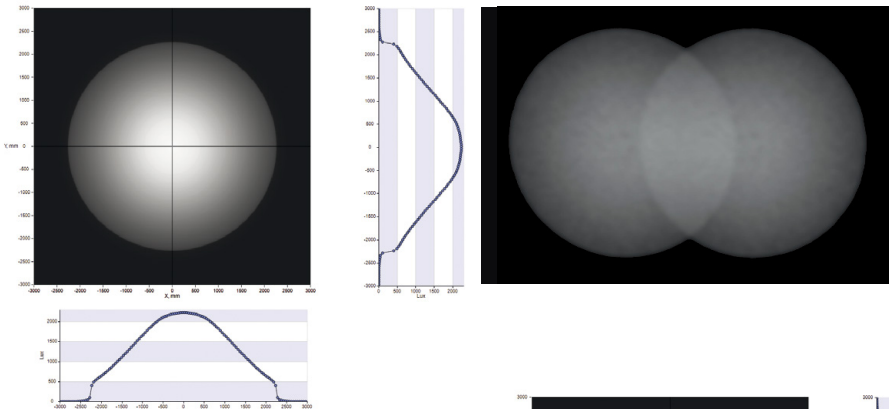

Hot-Spot beams with Frost

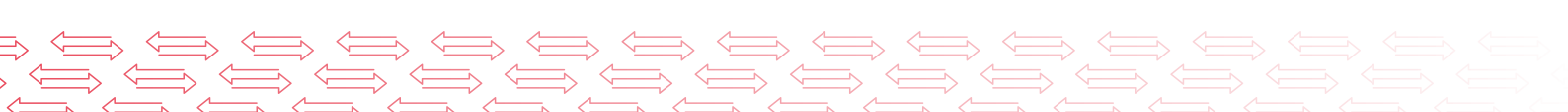
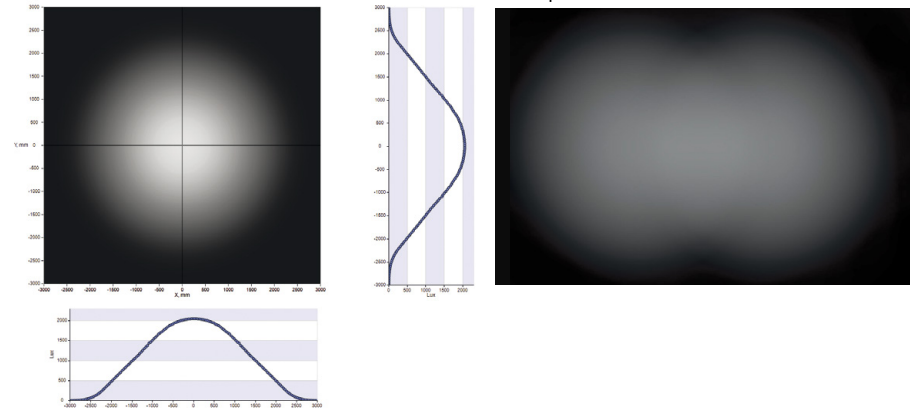

ESPRITE® Profile

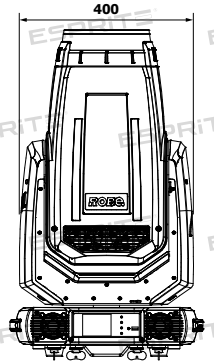
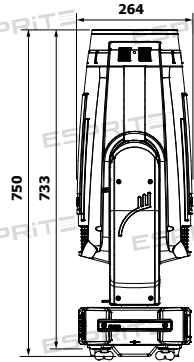
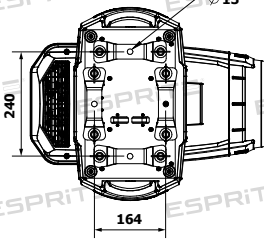
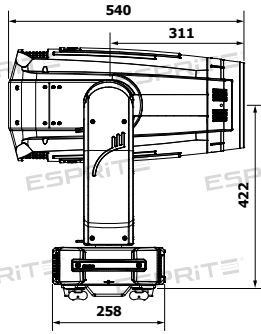
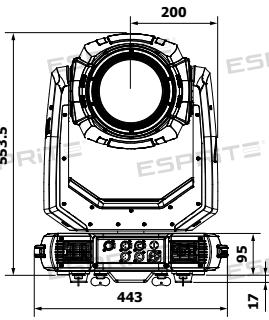

ESPRITE®

FS

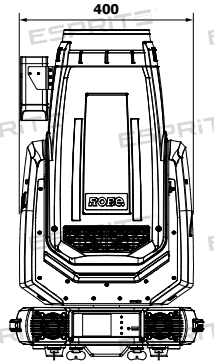
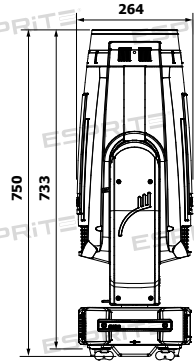
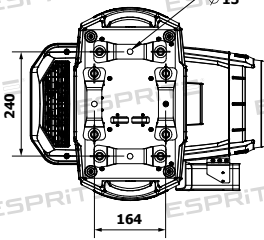
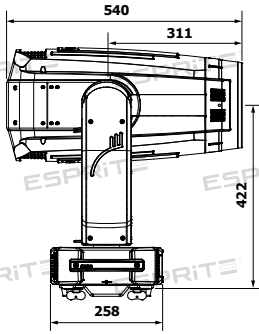
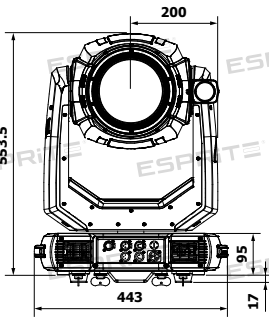

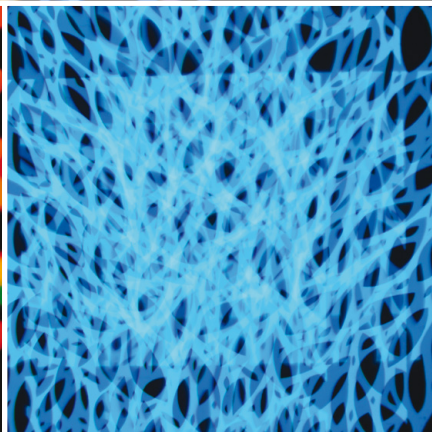
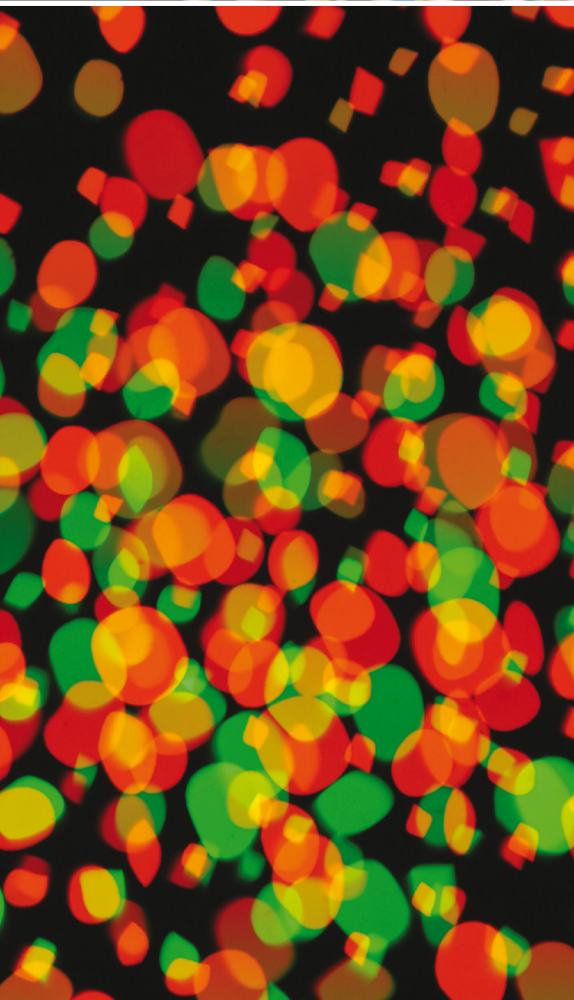
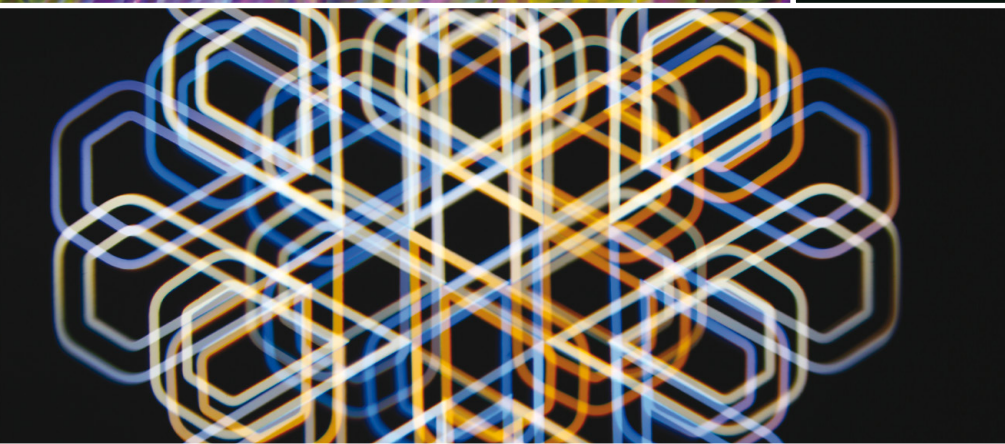
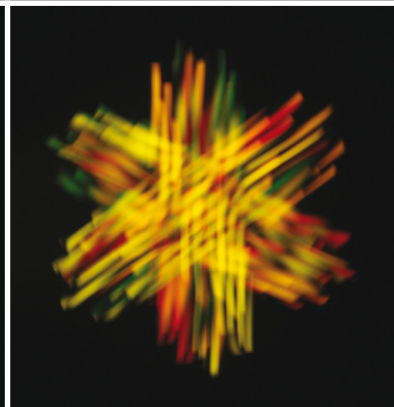
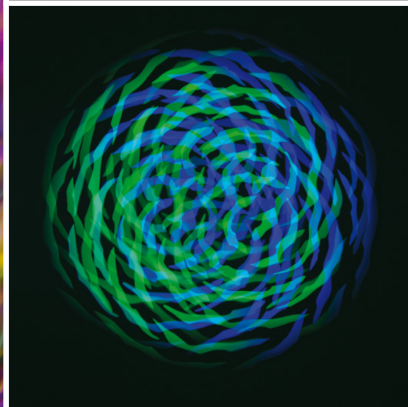
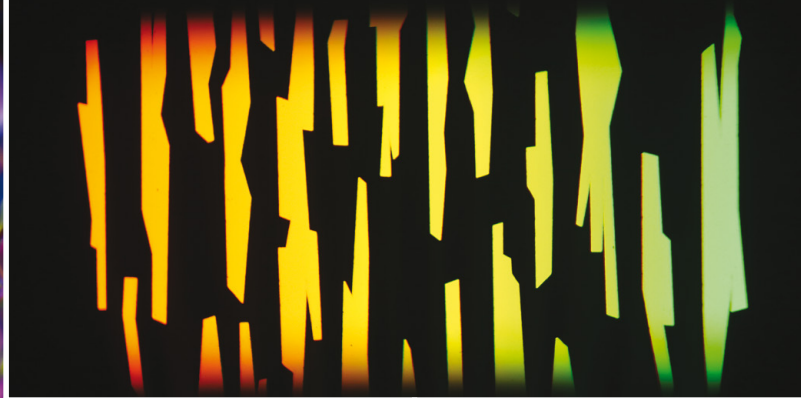

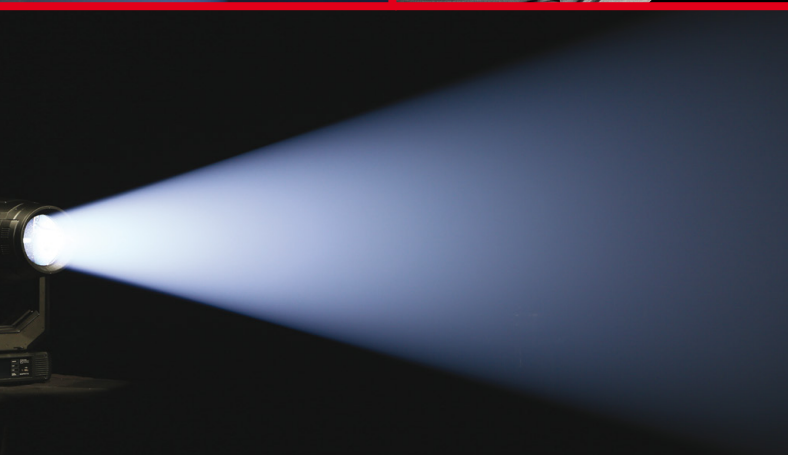
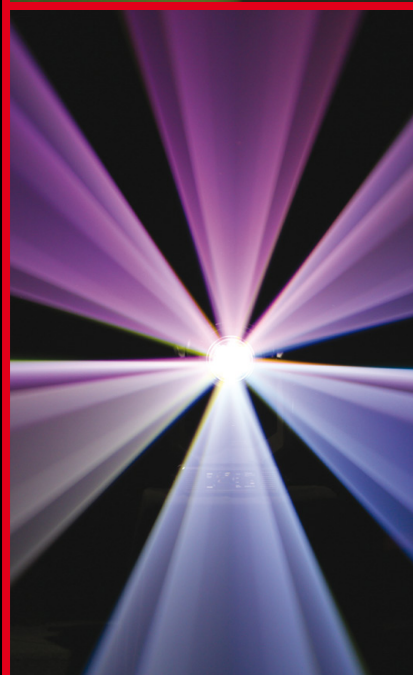
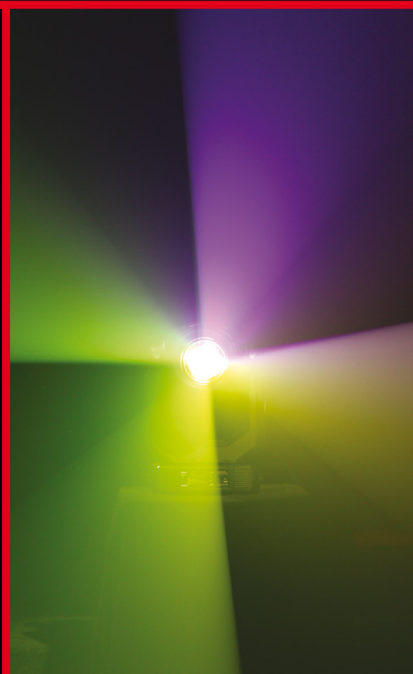
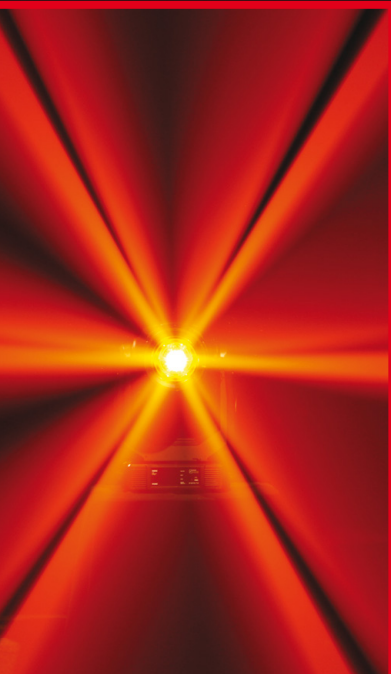
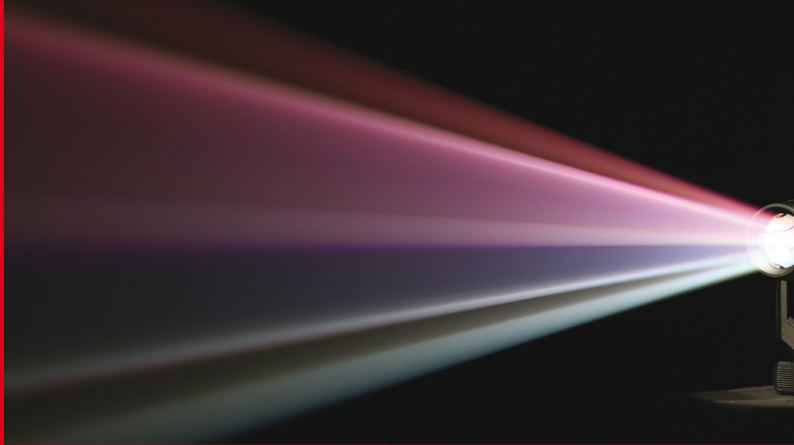
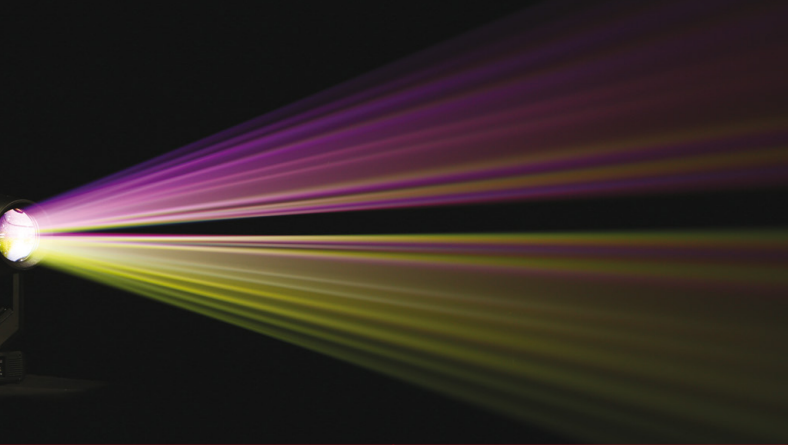

ESPRITE®

TRANSFERABLE ENGINE



Packaging

Cardboard - 505 x 390 x 800 mm

Single Top Loader Case - 790 x 600 x 880 mm

Dual Top Loader Case - 1330 x 600 x 790 mm



www.robe.cz



Head office: ROBE lighting s. r. o. | Hážovice 2090 | 756 61 Rožnov pod Radhoštěm | Czech Republic

Factory: ROBE lighting s. r. o. | Palackého 416 | 757 01 Valašské Meziříčí | Czech Republic

Tel.: +420 571 751 500 | E-mail: robe@robe.cz

July 2025 © ROBE lighting s. r. o. All specifications subject to change without notice.